

**ELECTRICAL OPTIONS/ SPECIFICATIONS**

OUTPUT	SUPPLY (NOM.)		
'A' 0.5 - 4.5V RATIO METRIC	5V		
SUPPLY CURRENT 12mA TYP. 20mA MAX.			
CONNECTIONS;	CABLE 3-CORE	CABLE 5-CORE	CONNECTOR
+ve	RED	RED	:1
+ SENSE (5-WIRE ONLY)	-	ORANGE	:1
0V	BLACK	BLACK	:3
- SENSE (5-WIRE ONLY)	-	GREY	:3
OUTPUT	WHITE	WHITE	:2
BODY	SCREEN	SCREEN	:4

CABLE: 0.2mm<sup>2</sup>, O/A SCREEN, PUR JACKET, SUPPLIED WITH 50cm OR REQUIRED LENGTH IN cm (15000cm MAX).  
 STANDARD 3-CORE: BLACK Ø4mm JACKET e.g. L50  
 OPTIONAL 5-CORE: BLUE Ø4.6mm JACKET e.g. LQ50  
 CONNECTORS: MAXIMUM CONDUCTOR CROSS SECTION 0.25mm<sup>2</sup>

RANGE OF DISPLACEMENT FROM 0-51mm TO 0-100mm IN INCREMENTS OF 1mm e.g.76.  
 BODY MATERIAL:- STAINLESS STEEL.  
 FLANGE BASE MATERIAL:- STAINLESS STEEL (CODE 'N')

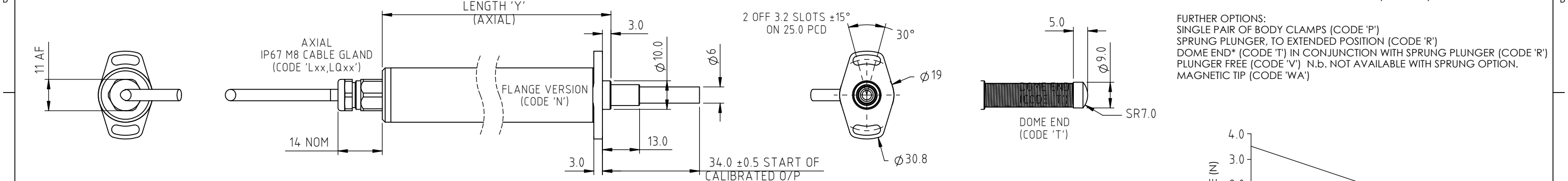

**FURTHER OPTIONS:**  
 SINGLE PAIR OF BODY CLAMPS (CODE 'P')  
 SPRUNG PLUNGER, TO EXTENDED POSITION (CODE 'R')  
 DOME END\* (CODE 'T') IN CONJUNCTION WITH SPRUNG PLUNGER (CODE 'R')  
 PLUNGER FREE (CODE 'V') N.b. NOT AVAILABLE WITH SPRUNG OPTION.  
 MAGNETIC TIP (CODE 'WA')

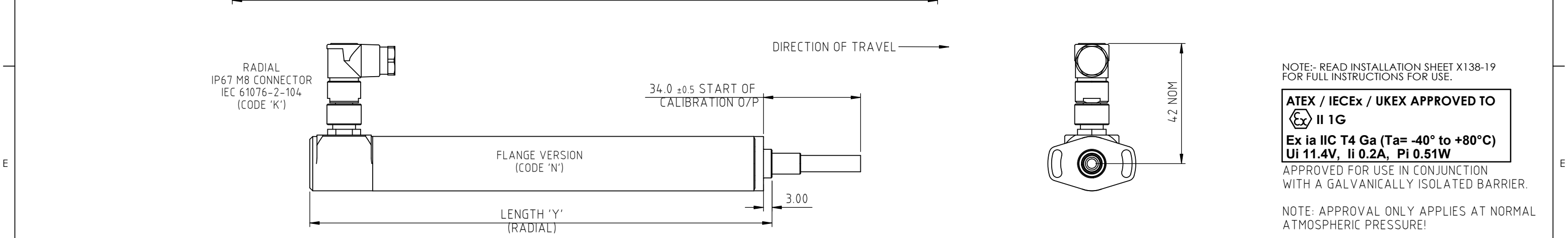
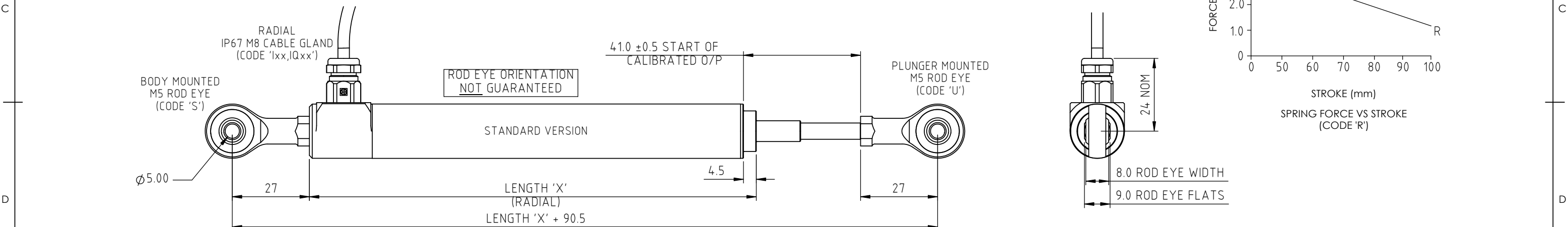
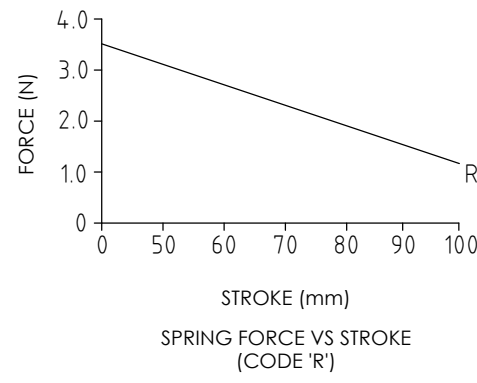

NOTE:- READ INSTALLATION SHEET X138-19 FOR FULL INSTRUCTIONS FOR USE.

**ATEX / IECEx / UKEX APPROVED TO**  
**II 1G**  
**Ex ia IIC T4 Ga (Ta= -40° to +80°C)**  
**Ui 11.4V, li 0.2A, Pi 0.51W**

APPROVED FOR USE IN CONJUNCTION WITH A GALVANICALLY ISOLATED BARRIER.

NOTE: APPROVAL ONLY APPLIES AT NORMAL ATMOSPHERIC PRESSURE!

DRAWINGS NOT TO BE CHANGED WITHOUT REFERENCE TO THE CHANGE PROCEDURE.  
 CHANGES TO PARTS USED IN INTRINSICALLY SAFE PRODUCT MUST BE APPROVED BY THE AUTHORISED PERSON.  
 THIS IS AN UNCONTROLLED PRINT AND WILL NOT BE UPDATED.

REV	CHANGE HISTORY	DR'WN	DATE	CHK'D
D	MAG TIP & RADIAL END CAP/ROD EYES RAN 1311/1312	ASC	31/03/2021	PDM

NOTE: SENSORS WITH TRAVEL UP TO 50mm ARE MADE IN STANDARD LENGTHS

TRAVEL (mm)		'X' STANDARD		'Y' FLANGE	
CALIBRATED	MECHANICAL	AXIAL	RADIAL	AXIAL	RADIAL
0-51 TO 0-70	70	137.5	156.5	143.0	162.0
0-71 TO 0-100	100	167.5	186.5	173.0	192.0

THE PLUNGER RETRACTS 8mm FROM START OF CALIBRATED TRAVEL (2mm FOR SPRUNG VERSIONS) AND EXTENDS 11mm\* BEYOND END OF MECHANICAL TRAVEL.  
 \*DOES NOT INCLUDE DIFFERENCE BETWEEN CALIBRATED AND MECHANICAL TRAVEL.  
 DIMENSIONS ARE NOMINAL.  
 'V' CODED PLUNGER WILL DEPART SENSOR BODY.



APPROVED BY	REV		X ±0.4 X.X ±0.2 X.XX ±0.1 DIMS mm
RDM	D		
DESCRIPTION <b>X138 INTRINSICALLY SAFE MID STROKE SLIM-LINE LINEAR POSITION SENSOR</b>			
SCALE	DRAWING NUMBER		
A3	X138-11		

SHEET 1 OF 1



# X138 MID STROKE SLIM-LINE LINEAR POSITION SENSOR INTRINSICALLY SAFE FOR HAZARDOUS GAS/VAPOUR ATMOSPHERES

- **Intrinsically safe for Gas to: Ex II 1G**
- **Non-contacting inductive technology to eliminate wear**
- **Travel set to customer's requirement**
- **Compact 19 mm diameter body**
- **High durability and reliability**
- **High accuracy and stability**
- **Sealing to IP67**



As a leading designer and manufacturer of linear, rotary, tilt and intrinsically safe position sensors, Positek® has the expertise to supply a sensor to suit a wide variety of applications.

Our intrinsically safe X138 incorporates electronics system EX07 which is ATEX / IECEx / UKEX approved for use in potentially explosive **gas/vapour** atmospheres. The X138 is designed for a wide range of industrial applications and is ideal for OEMs seeking good sensor performance in situations where a small diameter, short-bodied sensor is required for operation in hazardous areas. The unit is compact and space-efficient, being responsive along almost its entire length, and like all Positek® sensors provides a linear output proportional to travel. Each unit is supplied with the output calibrated to the travel required by the customer, from 51 to 100mm and with full EMC protection built in. Overall performance, repeatability and stability are outstanding over a wide temperature range. The sensor has a compact 19 mm diameter stainless steel body, is easy to install and set up. Mounting options include flange, M5 rod eye bearings and body clamps. The plunger can be supplied free or captive, with a female M4 thread, an M5 rod eye, magnetic tip, or spring-loaded with a dome end. The X138 also offers a range of mechanical options, environmental sealing is to IP67.

## SPECIFICATION

### Dimensions

Body diameter	19 mm	
Body length dependant on options		
Calibrated Travel	Axial	Radial
(Standard)		
51 mm to 70 mm	137.5 mm	156.5mm
71 mm to 100 mm	167.5 mm	186.5 mm
(Flange)		
51 mm to 70 mm	143 mm	162 mm
71 mm to 100 mm	173 mm	192 mm
Plunger	Ø 6mm	

*For full mechanical details see drawing X138-11*

### Independent Linearity

≤ ± 0.25% FSO @ 20°C

### Temperature Coefficients

< ± 0.01%/°C Gain &

< ± 0.01%FS/°C Offset

> 10 kHz (-3dB)

### Frequency Response

Infinite

< 0.02% FSO

### Noise

Ex II 1G

Ex ia IIC T4 Ga (Ta= -40°C to 80°C)

Approval only applies to the specified ambient temperature range and atmospheric conditions in the range 0.80 to 1.10 Bar, oxygen ≤ 21%

Sensor Input Parameters Ui: 11.4V, Ii: 0.20A, Pi: 0.51W.

(connector option/s) Ci: 1.16µF, Li: 50µH

(cable option/s) Ci: 1.36µF, Li: 860µH with 1km max. cable

### Environmental Temperature Limits

Operating -40°C to +80°C

Storage -40°C to +125°C

Sealing IP67

EMC Performance EN 61000-6-2, EN 61000-6-3

Vibration IEC 68-2-6: 10 g

Shock IEC 68-2-29: 40 g

MTBF 350,000 hrs 40°C Gf

### Drawing List

X138-11 Sensor Outline

3D models, step or .igs format, available on request.

**Do you need a position sensor made to order to suit a particular installation requirement or specification? We'll be happy to modify any of our designs to suit your needs - please contact us with your requirements.**

For further information please contact:

[www.positek.com](http://www.positek.com) [sales@positek.com](mailto:sales@positek.com)

Tel: +44(0)1242 820027 fax: +44(0)1242 820615

Positek, Andoversford Industrial Estate, Cheltenham GL54 4LB. U.K.





# X138 MID STROKE SLIM-LINE LINEAR POSITION SENSOR INTRINSICALLY SAFE FOR HAZARDOUS GAS/VAPOUR ATMOSPHERES

Intrinsically safe equipment is defined as "equipment which is incapable of releasing sufficient electrical or thermal energy under normal or abnormal conditions to cause ignition of a specific hazardous atmosphere mixture in its most easily ignited concentration."  
ATEX / IECEx / UKEX approved to;

Ex II 1G  
Ex ia IIC T4 Ga (Ta= -40°C to 80°C)

Designates the sensor as belonging to; Group II: suitable for all areas **except mining**, Category 1 G: can be used in areas with continuous, long or frequent periods of exposure to hazardous gas / vapour (Zones 2 to 0).

Gas / Vapour:

Protection class ia, denotes intrinsically safe for all zones

Apparatus group IIC: suitable for IIA, IIB and IIC explosive gas / vapour.

Temperature class T4: maximum sensor surface temperature under fault conditions 135°C.

Ambient temperature range extended to -40°C to +80°C.

It is imperative Positek® intrinsically safe sensors be used in conjunction with a galvanic barrier to meet the requirements of the product certification. The Positek X005 Galvanic Isolation Amplifier is purpose made for Positek IS sensors making it the perfect choice. Refer to the X005 datasheet for product specification and output configuration options.

For cable lengths exceeding 10 metres a five wire connection is recommended to eliminate errors introduced by cable resistance and associated temperature coefficients.

ATEX / IECEx / UKEX approved sensors suitable for dust (E series) and mining (M series) applications, are also available from Positek.

X138	a	b	c	d	e	f	g	h	j
	Displacement	A	Connections	Option	Option	Option	Option	Option	Z000

a <b>Displacement</b>	Value
Factory set to any length from 0-51 mm to 0-100 mm (e.g. 0-76 mm)	<b>76</b>
<b>b Output</b>	
Supply $V_{dc}$ (tolerance)	<b>Output</b>
+5V (4.5 - 5.5V)	0.5 - 4.5V (ratiometric with supply)
Supply Current 10mA typical, 12mA max.	<b>A</b>
<b>c Connections</b>	<b>Code</b>
Cable gland radial IP67 M8, metal, 3-core cable	<b>Ixx</b>
Cable gland radial IP67 M8, metal, 5-core cable	<b>IQxx</b>
Connector axial IP67 4 pin M8 IEC 61076-2-104, nylon	<b>J</b>
Connector axial IP67 4 pin M8 IEC 61076-2-104, nylon, pre-wired 3-core cable	<b>Jxx</b>
Connector radial IP67 4 pin M8 IEC 61076-2-104, nylon	<b>K</b>
Connector radial IP67 4 pin M8 IEC 61076-2-104, nylon, pre-wired 3-core cable	<b>Kxx</b>
Cable gland axial IP67 M8, metal, 3-core cable	<b>Lxx</b>
Cable gland axial IP67 M8, metal, 5-core cable	<b>LQxx</b>
Specify required cable length 'xx' in cm. e.g. L2000 specifies axial cable gland with 20 m of cable, 50 cm supplied as standard. <b>Note!</b> maximum length supplied 15000cm. <b>N.b.!</b> M8 connector option with 5-core cable not available.	

d <b>Housing</b>	Code
Standard default	blank
Flange Mount 2 off 3.2 mm x 30 degree wide slots, 25 mm P.C.D.	<b>N</b>
M5 Rod-eye bearing radial version only	<b>S</b>
<b>e Body Fittings</b>	<b>Code</b>
None default	blank
Body Clamps 1 pair	<b>P</b>
<b>f Sprung Plunger</b>	<b>Code</b>
Not sprung default	blank
Spring extend captive plunger only. Note! Supplied loose without option 'T'	<b>R</b>
<b>g Plunger Fittings</b>	<b>Code</b>
Female thread M4x0.7x7 deep default	blank
Dome end with spring extend option 'R'	<b>T</b>
M5 Rod-eye Bearing	<b>U</b>
Magnetic Tip	<b>WA</b>
<b>h Plunger</b>	<b>Code</b>
Captive plunger is retained - default	blank
Non-captive plunger can depart body	<b>V</b>
<b>j Z-code</b>	<b>Code</b>
Calibration to suit X005 required	<b>Z000</b>
$\leq \pm 0.1\%$ FSO @20°C Independent Linearity	<b>Z650</b>

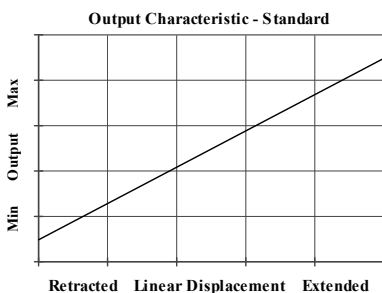

For further information please contact:

[www.positek.com](http://www.positek.com) [sales@positek.com](mailto:sales@positek.com)

Tel: +44(0)1242 820027 fax: +44(0)1242 820615

Positek, Andoversford Industrial Estate, Cheltenham GL54 4LB. U.K.



# Three or Five-Wire Mode Connection FOR INTRINSICALLY SAFE SENSORS IN HAZARDOUS ATMOSPHERES

The aim of this document is to help readers who do not understand what is meant by three or five wire modes of connection between the galvanic isolation amplifier and sensor, and the factors behind them. It is by no means an in-depth technical analysis of the subject.

Whether opting for a pre-wired Positek® Intrinsicly Safe sensor or one with a connector, choosing the right mode of connection and cable to suit the application requires careful consideration.

Interconnecting cables are not perfect conductors and offer resistance to current flow, the magnitude of resistance<sup>†</sup> depends on conductors resistivity, which changes with temperature, cross sectional area<sup>‡</sup> and length. If the voltage were to be measured at both ends of a length of wire it would be found they are different, this is known as volts drop. Volts drop changes with current flow and can be calculated using Ohm's law, it should be noted that volts drop occurs in both positive and negative conductors. The effects of volts drop can be reduced by increasing the conductors cross sectional area, this does not however eliminate the effects due to temperature variation. There are instances where large cross-section cables are not practical; for example most standard industrial connectors of the type used for sensors have a maximum conductor capacity of 0.75mm<sup>2</sup>, copper prices and ease of installation are other considerations.

This is important because the effects of volts drop can significantly alter the perceived accuracy of the sensor which is ratiometric i.e. the output signal is directly affected by the voltage across the sensor. Changes in temperature will also be seen as gain variation in the sensor output.

**Three wire mode** connections are common and are suitable in most cases with short or moderate cable runs. Applications that do not require a high degree of accuracy but have cable runs, say in excess of 10m, volts drop can be reduced by introducing a terminal box close to the sensor and using a larger cross-section cable for a majority of the cable run. Sensors supplied with three core cable are calibrated with the cable fitted which largely eliminates errors due to conductor resistance at room temperature however, as mentioned above, small gain errors due to temperature fluctuations should be expected.

**Five wire mode** connections have significant benefits as losses in the positive and negative conductors are compensated for by the galvanic isolation amplifier which can 'sense' the voltage across the sensor and dynamically adjust the output voltage so that the voltage across the sensor is correct. The effects of cable resistance and associated temperature coefficients are eliminated allowing for smaller conductors than a three wire connection for the same cable run. The amplifier can compensate for up to 15Ω per conductor with a current flow of 15mA, which is more than adequate for 150m of 0.25 mm<sup>2</sup> cable, longer lengths will require larger conductors.

**For this reason Positek® recommends five wire connections for cable lengths exceeding 10 metres in 0.25 mm<sup>2</sup> cable to preserve the full accuracy of the sensor.**

See illustrations below for examples of connecting a sensor to the galvanic isolation amplifier.

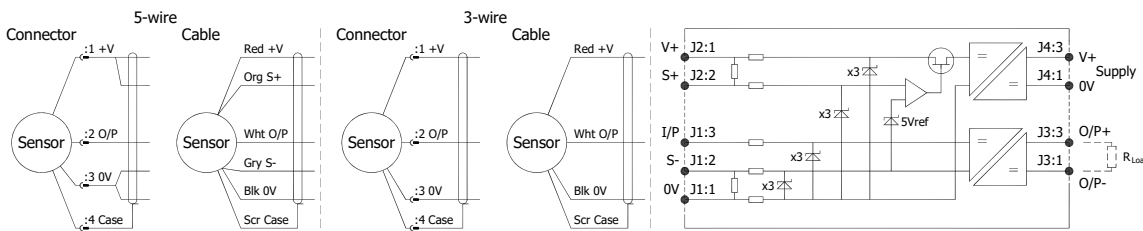

Cable Length (metres)	Up to 150	150 - 300	300 - 450	450 - 600	600 - 900	900 - 1000
Cross Section (mm <sup>2</sup> )	0.25	0.5	0.75	1.0	1.5	2.0

The table above shows recommended conductor sizes with respect to cable length for both three and five wire connections, based on copper conductors. Three wire connections will introduce a gain reduction of 5% and a ±1% temperature dependence of gain over the range -40°C to +80°C for the cable temperature. (i.e. about -150 ppm/°C for the maximum lengths shown and less pro rata for shorter lengths.)

It should be noted that the maximum cable length, as specified in the sensor certification, takes **precedence** and **must not** be exceeded.

Positek® sensors are supplied with three core 0.25 mm<sup>2</sup> cable as standard, however five core 0.25 mm<sup>2</sup> cable can be supplied on request. The galvanic isolation amplifier is available as;

G005-\*\*\* for 'G' and 'H' prefix sensors  
X005-\*\*\* for 'E', 'M' and 'X' prefix sensors

<sup>†</sup>  $R = \rho L/A$   $\rho$  is the resistivity of the conductor ( $\Omega m$ )  $L$  is the length of conductor (m)  $A$  is the conductor cross-sectional area (m<sup>2</sup>).

<sup>‡</sup> It is presumed that direct current flow is uniform across the cross-section of the wire, the galvanic isolation amplifier and sensor are a dc system.



For further information please contact:

[www.positek.com](http://www.positek.com) [sales@positek.com](mailto:sales@positek.com)

Tel: +44(0)1242 820027 fax: +44(0)1242 820615

Positek, Andoversford Industrial Estate, Cheltenham GL54 4LB. U.K.



# Installation Information

## X138 MID STROKE SLIM-LINE LINEAR POSITION SENSOR

INTRINSICALLY SAFE FOR HAZARDOUS GAS/VAPOUR ATMOSPHERES

ATEX / IECEx / UKEX Qualified to Intrinsic Safety Standard Certificate numbers SIRA 13ATEX2371X IECEX SIR 13.0154X CSAE 21UKEX2537X		Ex II 1G Ex ia IIC T4 Ga (Ta = -40°C to +80°C)	
Electronics Version	Output Description:	Supply Voltage: V <sub>s</sub> (tolerance)	Load resistance:
EX07	0.5 - 4.5V (ratiometric with supply) [Output code 'A']	+5V (4.5 - 5.5V)	5kΩ min

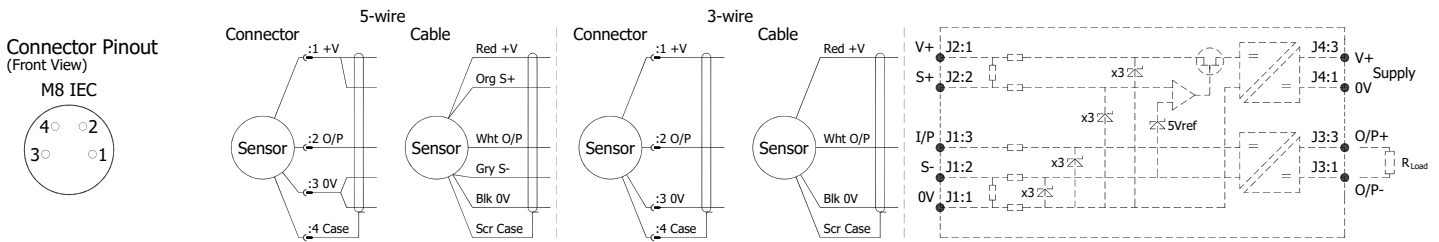

**Putting Into Service:** The sensor must be used with a galvanic isolation barrier designed to supply the sensor with a nominal 5V and to transmit the sensor output to a safe area. The barrier parameters must not exceed:-

**U<sub>i</sub> = 11.4V**      **I<sub>i</sub> = 0.20A**      **P<sub>i</sub> = 0.51W**  
**C<sub>i</sub> = 1.36μF\***      **Li = 860μH\*** (with maximum cable length)  
**C<sub>i</sub> = 1.16μF**      **Li = 50μH** (without cable)

\*Figures for 1km cable where: C<sub>i</sub> = 200pF/m & L<sub>i</sub> = 810nH/m

The sensor is certified to be used with up to **1000m** of cable, cable characteristics must not exceed:-

Capacitance: ≤ 200 pF/m or max. total of: 200 nF  
 Inductance: ≤ 810 nH/m or max. total of: 810 μH

Approval only applies to specified ambient temperature range and atmospheric conditions in the range: 0.80 to 1.10 Bar, oxygen ≤ 21%.

The performance of the sensor may be affected by voltage drops associated with long cable lengths; For cable lengths exceeding 10 metres a five wire connection is recommended to eliminate errors introduced by cable resistance and associated temperature coefficients.

**Special Condition for Safe Use:**

The apparatus does not meet the 500 V r.m.s dielectric strength test between circuit and frame, in accordance with clause 6.3.13 of IEC 60079-11:2011. This must be taken into consideration on installation.

Under certain extreme circumstances, the non-metallic and isolated metal parts incorporated in the enclosure of this equipment may generate an ignition-capable level of electrostatic charge. Therefore the equipment shall not be installed in a location where the external conditions are conducive to the build-up of electrostatic charge on such surfaces. This is particularly important if the equipment is installed in a zone 0 location. In addition, the equipment shall only be cleaned with a damp cloth.

**Use:** The sensor is designed to measure linear displacement and provide an analogue output signal.

**Assembly and Dismantling:** The unit is not to be serviced or dismantled and re-assembled by the user.

**Maintenance:** No maintenance is required.

**Mechanical Mounting:** Depending on options, body can be mounted by flange, rod eye bearings or clamping the sensor body - body clamps are available, if not already ordered. Plunger mounted by M4x0.7 female thread, rod-eye bearing or magnetic tip - see drawing X138-11.

**Output Characteristic:** Plunger extended by, at start of normal travel:

Standard: 41 mm\* from Ø19 mm face  
 Flange Mount : 34 mm\* from flange face

\*Note: where dome end option is fitted add 5 mm.

The output increases as the plunger extends from the sensor body, the calibrated stroke is between 51 mm and 100 mm.

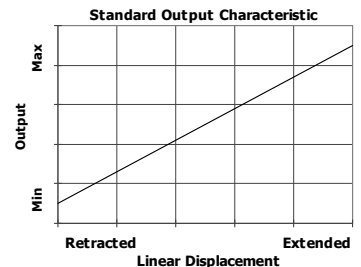

**Incorrect Connection Protection levels: Not protected** – the sensor is **not** protected against either reverse polarity or over-voltage. The risk of damage should be minimal where the supply current is limited to less than 50mA.



For further information please contact:

[www.positek.com](http://www.positek.com) [sales@positek.com](mailto:sales@positek.com)

Tel: +44(0)1242 820027 fax: +44(0)1242 820615

Positek, Andoversford Industrial Estate, Cheltenham GL54 4LB. U.K.